

# T4 2.4G LED RGBW Controller

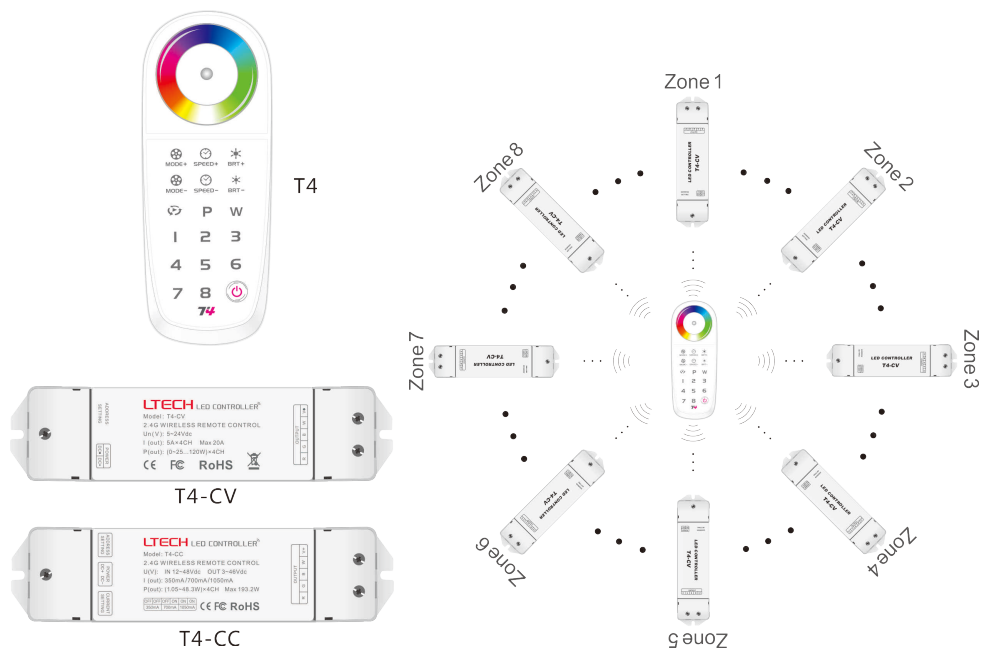

T4 is the 2.4GHz RF wireless sync/zone RGBW controller which adopts LTECH 4 global initiate technology (2 invention patents, 2 utility patents). It has powerful function that general RF remote control can't realize, especially in wireless connection between receivers to realize sync dynamic change effect. It is very convenient in installation for users. T4 is aggregated all the functions in the favored by customers RGB remote T3/T3M/T3X, but simple easy to use.

### Performance Features:

1. Adopt 2.4GHZ RF wireless transmission technology, which is applicable for license and patent free worldwide.
2. Advanced RF wireless sync control technology, no sync signal wire between receivers, sync capability is stable and reliable.
3. Remote adopts the capacitive touch control technology on the full color wheel, make the LED color selection more user-friendly.
4. With the latest DIY program method, editing effects is easier and more intuitive.
5. Build-in sync state light, can display the LED color in static or changing state synchronously.
6. Sync and zone switch freely.
7. Unmanned operation more than 1 min on the remote, the remote will automatically shut down to realize zero loss, extending operation life for the battery.
8. USB charging port.

### 1. Technical Specs:

#### T4 Remote

- Input Voltage: DC5V Built-in Lithium Battery
- Working Current: <30mA
- Working Frequency: 2.4GHZ
- RF Remote Distance: 30m
- Remote Option: Sync/Zone Control
- Grey Scale Level: 4096×4096×4096×4096
- Battery Capacity: 1000mAh
- Dimensions: L145×W55×H22(mm)
- Package Size: L168×W96×H34(mm)
- Weight (G.W.): 210g

#### T4-CV Receiver

- Input Voltage: DC5V~DC24V
- Max Current Load: 5A × 4CH Max 20A
- Max Output Power: 100W/240W/480W(5V/12V/24V)
- Working Temperature: -30℃~55℃
- Package Size: L178×W48×H33(mm)
- Weight (G.W.): 150g

#### T4-CC Receiver

- Input Voltage: DC12V~DC48V
- Output Voltage: DC3V~DC46V
- Current Load: CC 350/700/1050mA×4CH (3 in 1)
- Output Power: 1.05W~48.3W×4CH Max193.2W
- Working Temperature: -30℃~55℃
- Package Size: L178×W48×H33(mm)
- Weight (G.W.): 165g

### 2. The Charging Methods for Remote Control:

1. When charging, please connect USB cable to the mobile charger or computer.
2. The blue indicator light flickers while charging, and turns green means the charging is completed. The remote can be chargeable even at off state, which the indicator light is dark.
3. No memory effect in the lithium battery of remote. Follow the standard charging procedure even for the first three times, no need over charge.
4. Red indicator light flickers meaning low battery and need to be charged. charging in low battery will affect life of battery.
5. the remote should be full charged and stored under low cold drying while a long time without being operated. And please full recharge every 3 months.

### 3. Product Size:

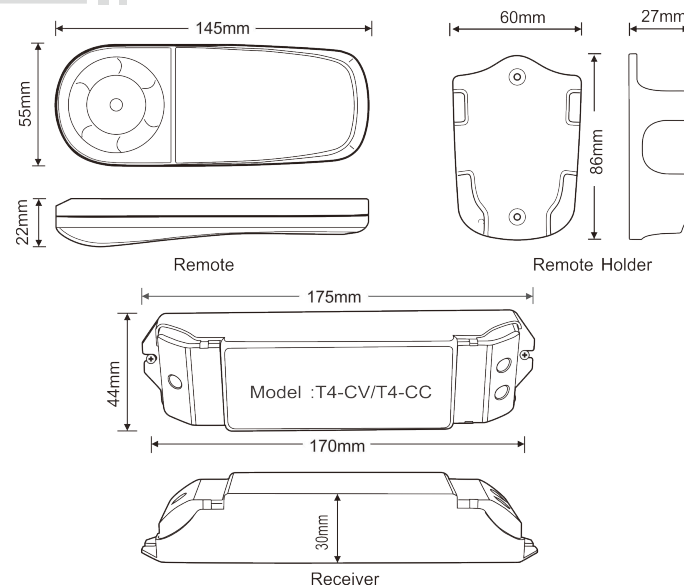

4. Receiver Components Description:

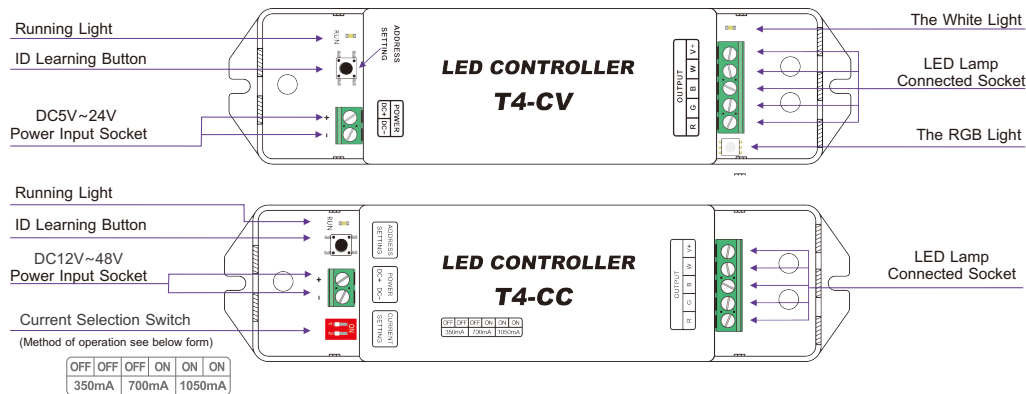

5. The Learning ID Method of Remote:

Learning ID:

1. Turn on the receiver and remote.
2. Short press "ID learning button" on the receiver, the running light keeps on, then long press 1-8 zone-selection keys on the remote, the running light returns to flash (the buzzer long beep, the green light flashes 3 times), activated successful.

Cancelling ID:

Press "ID learning button" on the receiver more than 8 seconds, the buzzer beep twice, delete all the learned remote.

\* sync control: 1 remote to unlimited receivers. zone control: 1 remote to Max 8 receivers ( 1 receiver per zone ).

6. Remote Control Instructions:

Built-in two control programs, it is convenient for user's different habits and place, free switching the two programs.

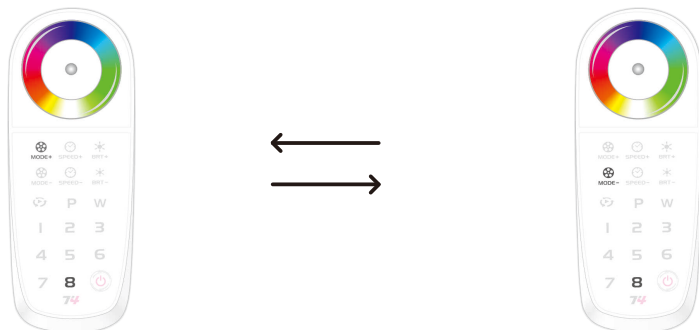

**Sync control** : Press the key and **8** over 2 seconds.

Highlights: control unlimited receivers synchronously; programmable function; 8 save keys.

**Zone control** : Press the key and **8** over 2 seconds.

Highlights: zone control arbitrarily; sync control; programmable function.

\* **Power Saving**: unmanned operation more than 1 min on the remote, the remote will automatically shut down to realize zero loss, extending operation life. Press ON/OFF again, it will restart the remote.

**Mode keys** : Switch black/red/green/blue/yellow/purple/cyan/white/RGB/RGBYPCW

**Open the buzzer**: long press **Close the buzzer**: long press

A. Sync Program:

The Usage of The Programming "P" :

1) Long press the key **P** in 2 seconds, buzzer sounds, enter the programming mode.

2) Color selection : Saved 8 colors in NO. 1-8, press NO. 

1	2	3
4	5	6
7	8	

 in order and press MODE or color circle

again to select the color.

(color will be saved in this key automatically).

Example1: 

1	2	3	4	5	6	7	8
Red	Green	Blue	Yellow	Purple	Cyan	White	Black

**R G B Y P C W** 7 Colors' Skipping/Smooth/Strobe

Example2: 

1	2	3	4	5	6	7	8
Red	Blue	Black	Black	Black	Black	Black	Black

**R B** 2 Colors' Skipping/Smooth/Strobe

Example3: 

1	2	3	4	5	6	7	8
Red	Black	Green	Black	Blue	Black	Black	Black

**R BK G BK B** 5 Colors' Skipping/Smooth/Strobe

Example4: 

1	2	3	4	5	6	7	8
Black	Red	Black	Green	Black	Blue	Black	Black

**R G B** 3 Colors' Fade out and fade in **BK R BK G BK B** 6 Colors' Skipping/Strobe

Note: Select Black color with keys

3) Short press "P" key **P** to exit color selection.

4) press to switch the selected colors' skipping, smooth and strobe (Brightness/Speed adjustment).

5) Long press any key in 1-8 

1	2	3
4	5	6
7	8	

 to save the edited scene.

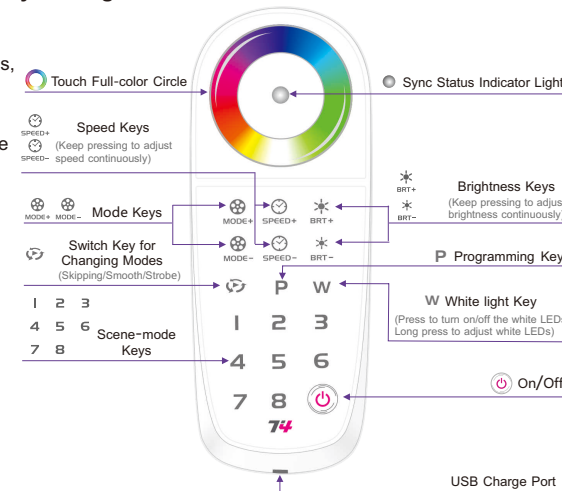

B. Zone Program:

The Usage of The Programming "P" :

1) Long press the key **P** in 2 seconds, buzzer sounds, enter the programming mode.

2) Color selection : Saved 8 colors in NO. 1-8, press NO. 

1	2	3
4	5	6
7	8	

 in order and press MODE or color circle

again to select the color.

(color will be saved in this key automatically).

Example1: 

1	2	3	4	5	6	7	8
Red	Green	Blue	Yellow	Purple	Cyan	White	Black

**R G B Y P C W** 7 Colors' Skipping/Smooth/Strobe

Example2: 

1	2	3	4	5	6	7	8
Red	Blue	Black	Black	Black	Black	Black	Black

**R B** 2 Colors' Skipping/Smooth/Strobe

Example3: 

1	2	3	4	5	6	7	8
Red	Black	Green	Black	Blue	Black	Black	Black

**R BK G BK B** 5 Colors' Skipping/Smooth/Strobe

Example4: 

1	2	3	4	5	6	7	8
Black	Red	Black	Green	Black	Blue	Black	Black

**R G B** 3 Colors' Fade out and fade in **BK R BK G BK B** 6 Colors' Skipping/Strobe

Note: Select Black color with keys



3) Short press "P" key **P** to exit color selection.

4) Press to switch the selected colors' skipping, smooth and strobe (Brightness/Speed adjustment).

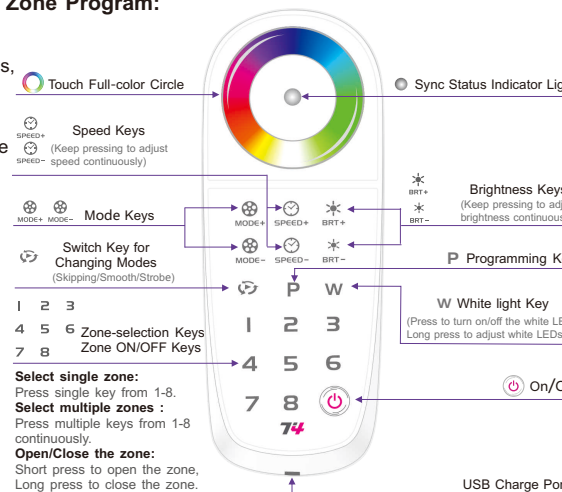
5) OK, completed scene editing, short press "P" to play the scene.



7. Tables of Changing Mode:

No.	Color (Press   Button to Switch)	Press  button to switch the 3 types		
		Skipping	Smooth	Strobe
1	Black			
2	Red	Static Red	Red Fade out and Fade in	Red Strobe
3	Green	Static Green	Green Fade out and Fade in	Green Strobe
4	Blue	Static Blue	Blue Fade out and Fade in	Blue Strobe
5	Yellow	Static Yellow	Yellow Fade out and Fade in	Yellow Strobe
6	Purple	Static Purple	Purple Fade out and Fade in	Purple Strobe
7	Cyan	Static Cyan	Cyan Fade out and Fade in	Cyan Strobe
8	White	Static White	White Fade out and Fade in	White Strobe
9	Red, Green, Blue	RGB Skipping	RGB Color Smooth	RGB Strobe
10	Red, Green, Blue, Yellow, Purple, Cyan, White	7 Colors Skipping	Full-color Smooth	7 Colors Strobe

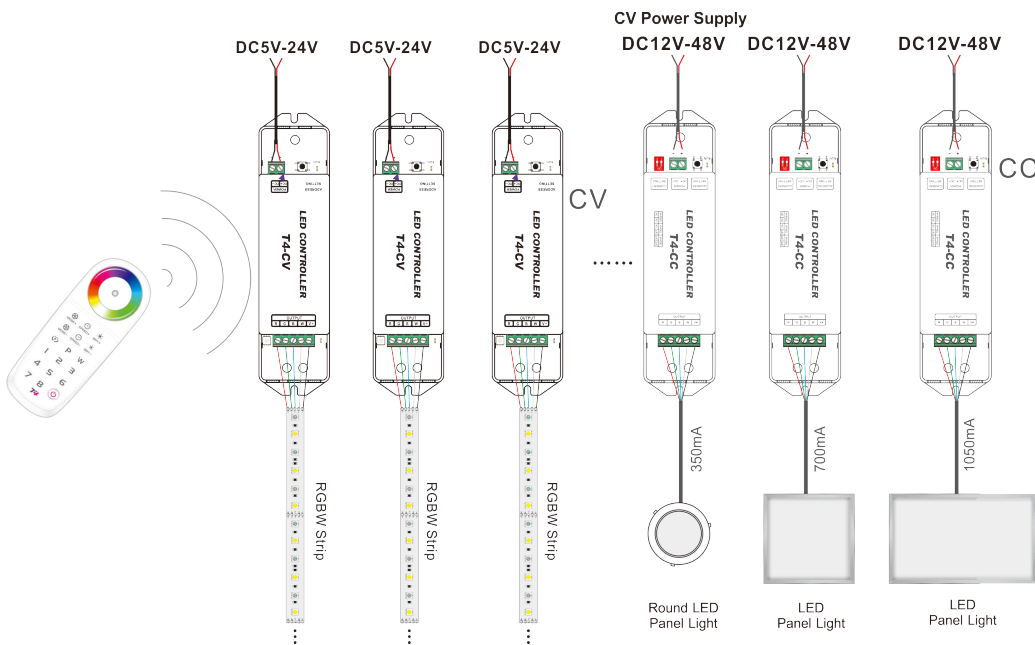

8. Wiring Diagram:



9. Other Special Functions:

A. Reset Function:

**Feature:** Reset function is available when remote operates abnormally.

**Operation:** Long press   simultaneously, release the 2 keys after 3 seconds, the remote will auto off, undo for more than 1 min. means reset completed. and then could restart the remote.



B. Check and Edit the Frequency Point on the Remote:

**Feature:**

- a. Revising the frequency point to eliminate the external disturbance. 12 revisable frequency points for user.
- b. Multiple remotes sync-control becomes available when they use the same frequency point.



**Attn:** After reset or revised the frequency points in the remote, receivers only can be used after relearn the ID.

**Check the Frequency Point on the Remote:**

Turn on the remote, long press the on/off key  for 5 seconds until the red light  flashes 3 times, and then the green light  flashes, the numbers of the green flash will be the frequency point of the remote. you can only edit the frequency point after 3 seconds.

**Edit the Frequency Point on the Remote:** In frequency changing state

Method 1: short press any key from 1-8, the frequency point will be 1-8 correspondingly, the green light will flash in the same numbers. Press again any key or touch the color circle to exit the frequency edit state.

Method 2: long press "on/off" key  over 5 seconds, the green light  flashes, the flash times plus 1 means the frequency point accumulate 1. In short, long press the "on/off" key  5 seconds each time, the frequency point will accumulate 1, which will again become value 1 when added to 12, and that cycle repeats.

10. Attention:

1. The product shall be installed and serviced by the qualified person.
2. This product is non-waterproof. Please avoid the sun and rain. When installed outdoors please ensure it is mounted in a water proof enclosure.
3. Good heat dissipation will prolong the working life of the controller. Please ensure good ventilation.
4. Please check if the output voltage of the LED power supply used comply with the working voltage of the product.
5. Please ensure that adequate sized cable is used from the controller to the LED lights to carry the current. Please also ensure that the cable is secured tightly in the connector.
6. Ensure all wire connections and polarities are correct before applying power to avoid any damages to the LED lights.
7. If a fault occurs please return the product to your supplier. Do not attempt to fix this product by yourself.

11. Warranty Agreement:

1. We provide lifelong technical assistance with this product:
  - A 5-year warranty is given from the date of purchase. The warranty is for free repair or replacement if cover manufacturing faults only.
  - For faults beyond the 5-year warranty we reserve the right to charge for time and parts.
2. Warranty exclusions below:
  - Any man-made damages caused from improper operation, or connecting to excess voltage and overloading.
  - The product appears to have excessive physical damage.
  - Damage due to natural disasters and force majeure.
  - Warranty label, fragile label and unique barcode label have been damaged.
  - The product has been replaced by a brand new product.
3. Repair or replacement as provided under this warranty is the exclusive remedy to the customer. LTECH shall not be liable for any incidental or consequential damages for breach of any stipulation in this warranty.
4. Any amendment or adjustment to this warranty must be approved in writing by LTECH only.

★This manual only applies to this model. LTECH reserves the right to make changes without prior notice.