

ECO INDUSTRIAL SUPPLIES

3 Andrew St Christie Downs South Australia 5164

Mobile +0061 0458 158 777

ABN: 25 145 151 241



LED Explosion Proof Linear Light KLE1011

KLE1011-ATEX Specification

LED Explosion Proof Light



CE RoHS



- II 2 G Ex emb IIC T6 Gb
- II 2 D Ex tb IIIC T80°C Db IP66
- -40°C to 55°C Ambient Temperature
- ATEX-2014/34/EU
 - EN 60079-0:2012+A11:2013
 - EN 60079-7:2015
 - EN 60079-18:2015
 - EN 60079-31:2014
- EMC-2014/30/EU
- LVD-2014/35/EU
- RoHS-2011/65/EU
- IK10
- RoHS-2015/863/EU



ECO INDUSTRIAL SUPPLIES

3 Andrew St Christie Downs South Australia 5164

Mobile +0061 0458 158 777

ABN: 25 145 151 241



LED Explosion Proof Linear Light KLE1011

LED Explosion Proof Light

Key Features:

- 1 Low-profile, lightweight design, high quality aluminum housing.
- 2 Impact resistant diffused lens with Bayer original material.
- 3 Stainless steel bracket for ceiling mount.
- 4 Professional light distribution, uniform illumination through the entire space.
- 5 With single-ended feedthrough or double-ended feedthrough optional.

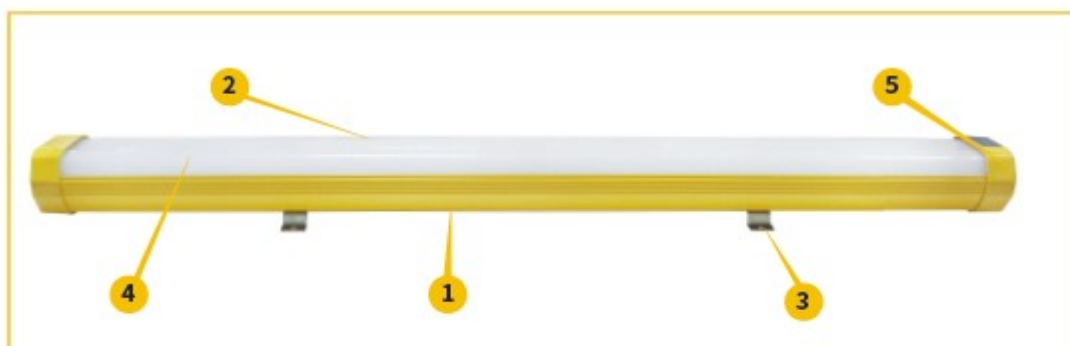

Additional Features:

- Standard 6-12KV surge protection
- Feed-through capable
- Enclosures attached to back brackets for pendant pole mount, pendant chain mount and 45 degree wall mount.
- Clear lens optional
- 5-year warranty

Standard Materials:

- Side cover: ADC12
- Gaskets: one-piece neoprene
- Body: 6063 aluminum (less than 0.4% copper content) with yellow-painted.
- Brackets: stainless steel
- Lens: polycarbonate

Features & Benefits:

- 1 Environmentally Friendly 50,000 hrs lifetime.
- 2 Superior color rendering index compared to HPS, LPS or MV.
- 3 Low temperature applications to -40°C and high temperature up to 55°C.
- 4 Best-in-class efficacy-Up to 110 lumens per watt.
- 5 Professional light distribution design, uniform and comfortable lighting.
- 6 Temperature compensation technology for longer life.
- 7 Low maintenance costs and power consumption reduced by over 50%.

ECO INDUSTRIAL SUPPLIES

3 Andrew St Christie Downs South Australia 5164

Mobile +0061 0458 158 777

ABN: 25 145 151 241



LED Explosion Proof Linear Light KLE1011

LED Explosion Proof Light

Certification Guide:

Model	Length	Wattage	Operating Voltage	Total Lumens	Lumen per Watt	CRI	CCT *	Ambient Temperature	Ex-mark for Gas	Ex-mark for Dust	Supply Wire Suitable Temperature
KLE1011U24C1	385mm	24W	100-277V 50/60Hz	2712	113	75	5034	-40°C<Tamb<55°C	Ex amb IIC T6 Gb	II 2D Extb IIIC T80°C Db IP66	80°C
KLE1011U36C2	685mm	36W	100-277V 50/60Hz	4212	117	75	5021	-40°C<Tamb<55°C	Ex amb IIC T6 Gb	II 2D Extb IIIC T80°C Db IP66	80°C
KLE1011U36C4	1285mm	36W	100-277V 50/60Hz	4680	130	75	5060	-40°C<Tamb<55°C	Ex amb IIC T6 Gb	II 2D Extb IIIC T80°C Db IP66	80°C
KLE1011U50C4	1285mm	50W	100-277V 50/60Hz	6250	125	75	5046	-40°C<Tamb<55°C	Ex amb IIC T6 Gb	II 2D Extb IIIC T80°C Db IP66	80°C
KLE1011U60C4	1285mm	60W	100-277V 50/60Hz	7380	123	75	5038	-40°C<Tamb<55°C	Ex amb IIC T6 Gb	II 2D Extb IIIC T80°C Db IP66	80°C
KLE1011U72C4	1285mm	72W	100-277V 50/60Hz	8424	117	74	5023	-40°C<Tamb<55°C	Ex amb IIC T6 Gb	II 2D Extb IIIC T80°C Db IP66	80°C
KLE1011U80C4	1285mm	80W	100-277V 50/60Hz	9120	114	75	5020	-40°C<Tamb<55°C	Ex amb IIC T6 Gb	II 2D Extb IIIC T80°C Db IP66	80°C
KLE1011U24D1	385mm	24W	100-277V 50/60Hz	2280	95	75	5034	-40°C<Tamb<55°C	Ex amb IIC T6 Gb	II 2D Extb IIIC T80°C Db IP66	80°C
KLE1011U36D2	685mm	36W	100-277V 50/60Hz	3456	96	75	5021	-40°C<Tamb<55°C	Ex amb IIC T6 Gb	II 2D Extb IIIC T80°C Db IP66	80°C
KLE1011U36D4	1285mm	36W	100-277V 50/60Hz	3888	108	74	5005	-40°C<Tamb<55°C	Ex amb IIC T6 Gb	II 2D Extb IIIC T80°C Db IP66	80°C
KLE1011U50D4	1285mm	50W	100-277V 50/60Hz	5250	105	75	5052	-40°C<Tamb<55°C	Ex amb IIC T6 Gb	II 2D Extb IIIC T80°C Db IP66	80°C
KLE1011U60D4	1285mm	60W	100-277V 50/60Hz	6180	103	75	5012	-40°C<Tamb<55°C	Ex amb IIC T6 Gb	II 2D Extb IIIC T80°C Db IP66	80°C
KLE1011U72D4	1285mm	72W	100-277V 50/60Hz	6912	96	74	5023	-40°C<Tamb<55°C	Ex amb IIC T6 Gb	II 2D Extb IIIC T80°C Db IP66	80°C
KLE1011U80D4	1285mm	80W	100-277V 50/60Hz	7600	95	75	5026	-40°C<Tamb<55°C	Ex amb IIC T6 Gb	II 2D Extb IIIC T80°C Db IP66	80°C

* All values typical unless otherwise stated (tolerance +/- 10%)

Technical Data for Emergency:

Dimensions for Lighting: 1285mm(36/50/60/72/80W)

Input Voltage: 100-277Vac, 50/60Hz

Output Voltage: 25-48VDC

Emergency Power: 15WMax

Emergency Time: 90Minutes

Recharge Time: 24Hours Battery Type:Ni-MH (Built-in)

Temperature Rating (Ambient): 0°Cto+50°C

Photometric Data:

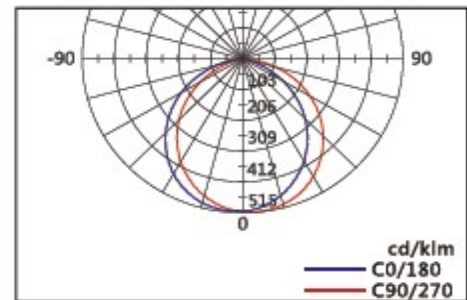

Fixture Dimensions(mm):

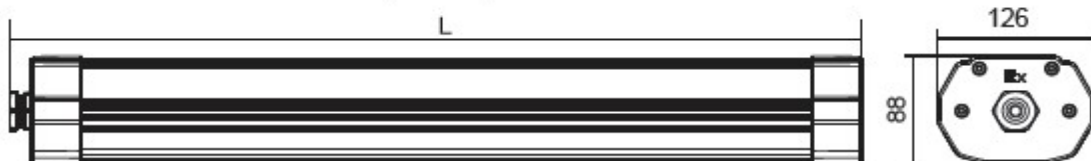

KLE1011 Series	Dimensions(mm)	Net Weight(kg)	Boxed Weight(kg)	Shipping Volume(m ³)
300mm models	L=385	2.8	4.0	0.014
600mm models	L=685	4.5	6.0	0.035
1200mm models	L=1285	7.5	9.7	0.063

ECO INDUSTRIAL SUPPLIES

3 Andrew St Christie Downs South Australia 5164

Mobile +0061 0458 158 777

ABN: 25 145 151 241



LED Explosion Proof Linear Light KLE1011

LED Explosion Proof Light

Accessories:

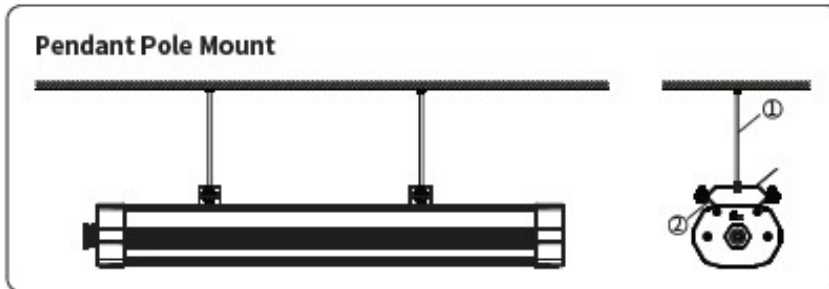

Pendant Pole Mount
Catalog Number:1011001
Qty: 1 kit
Shipping Weight: 0.64kg/kit

Mounting Type	Ordering	Part SN	Part Name	Ordering	Part Qty.	Material	Weight(kg/pcs)
Pendant Pole Mount	1011001	①	M8 Screw Pole(L=500MM)	1011009	2	sus304	0.2
		②	Bracket	1011008	4	sus304	0.06

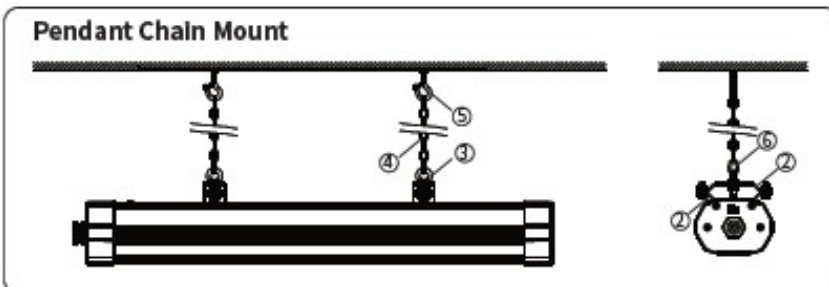

Pendant Chain Mount
Catalog Number:1011002
Qty: 1 kit
Shipping Weight: 0.66 kg/kit

Mounting Type	Ordering	Part SN	Part Name	Ordering	Part Qty.	Material	Weight(kg/pcs)
Pendant Pole Mount	1011002	②	Bracket	1011008	4	sus304	0.06
		③	Lifting Bolt	1011010	2	sus304	0.03
		④	Pendant Chain	1011011	2	sus304	0.1
		⑤	Expansion Hook	1011012	2	sus304	0.06
		⑥	Hanging buckle	1011013	2	sus304	0.02

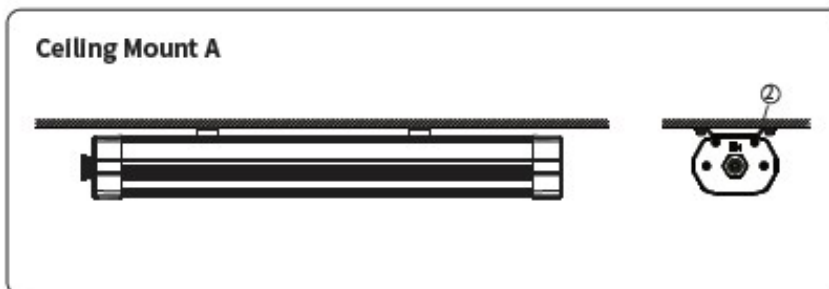

Ceiling Mount A
Catalog Number:1011003
Qty: 1 kit
Shipping Weight: 0.12 kg/kit

Mounting Type	Ordering Code	Part SN	Part Name	Ordering Code	Part Qty.	Material	Weight(kg/pcs)
Ceiling Mount A	1011003	②	Bracket	1011008	2	sus304	0.06

ECO INDUSTRIAL SUPPLIES

3 Andrew St Christie Downs South Australia 5164

Mobile +0061 0458 158 777

ABN: 25 145 151 241



LED Explosion Proof Linear Light KLE1011

LED Explosion Proof Light

Accessories:

Ceiling Mount B (adjustable angles)

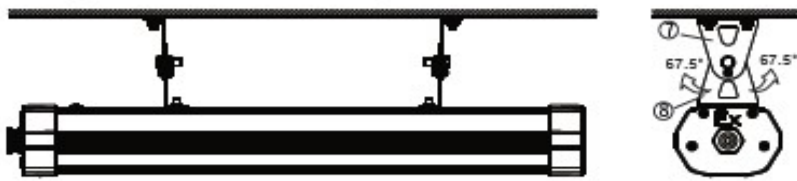

Ceiling Mount B
Catalog Number:1011004
Qty: 1 kit
Shipping Weight: 0.48 kg/kit

Mounting Type	Ordering	Part SN	Part Name	Ordering	Part Qty.	Material	Weight(kg/pcs)
Ceiling Mount B (adjustable angles)	1011004	⑦	Bracket	1011014	2	sus304	0.12
		⑧	Bracket	1011015	2	sus304	0.12

Wall Mount A



Wall Mount A
Catalog Number:1011005
Qty: 1 kit
Shipping Weight: 0.28 kg/kit

Mounting Type	Ordering	Part SN	Part Name	Ordering	Part Qty.	Material	Weight(kg/pcs)
Wall Mount A	1011005	⑨	V-Shape Bracket	1011016	2	Q235	0.08
		②	Bracket	1011008	2	sus304	0.06

Wall Mount B (adjustable angles)

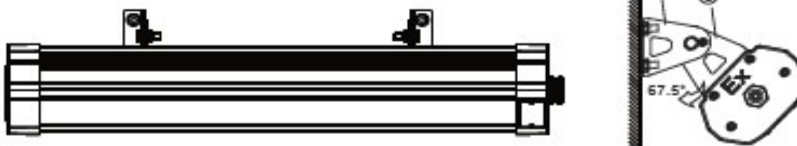

Wall Mount B
Catalog Number:1011004
Qty: 1 kit
Shipping Weight: 0.48 kg/kit

Mounting Type	Ordering	Part SN	Part Name	Ordering	Part Qty.	Material	Weight(kg/pcs)
Ceiling Mount B (adjustable angles)	1011004	⑦	Bracket	1011014	2	sus304	0.12
		⑧	Bracket	1011015	2	sus304	0.12

ECO INDUSTRIAL SUPPLIES

3 Andrew St Christie Downs South Australia 5164

Mobile +0061 0458 158 777

ABN: 25 145 151 241



LED Explosion Proof Linear Light KLE1011

LED Explosion Proof Light

Accessories:

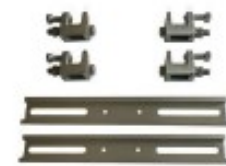
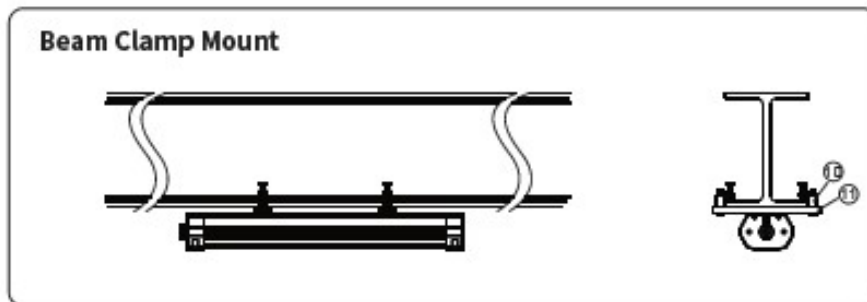

Beam Clamp Mount
 Catalog Number: 1011006
 Qty: 1 kit
 Shipping Weight: 0.64 kg/kit

Mounting Type	Ordering	Part SN	Part Name	Ordering	Part Qty.	Material	Weight(kg/pcs)
Beam Clamp Mount	1011006	⑩	Beam Clamp	1011017	4	sus304	0.12
		⑪	Aluminum Groove *	1011018	2	6063	0.08

* Suitable for steel I-beam with 4.33-8.26 inches width.



Pole Mount
 Catalog Number: 1011007
 Qty: 1 kit
 Shipping Weight: 0.34 kg/kit

Mounting Type	Ordering	Part SN	Part Name	Ordering	Part Qty.	Material	Weight(kg/pcs)
Pole Mount	1011007	⑫	Bracket	1011008	2	sus304	0.06
		⑪	Hoop	1011019	2	sus304	0.05
		⑫	U-Shape Pipe Clamp	1011020	2	sus304	0.06