

LED Explosion Proof Lighting

APPEARANCE



- Self-developed with ready patent (no. ZL2010202338350)
- IP68 waterproof protection
- Material: Die-casting Aluminum Alloy ADC12
- Power coating: Sprayed with unique paint material, good heat transmission
- Lens: Toughened glass, 4mm thickness, shock & vibration resistant, >95% light transmit
- Gasket: water proof silicon, top quality rubber with anti-low aging and burn-proof characteristic

LED LIGHT ENGINE

- Bridgelux 3030 chip, LM80 Certify
- Efficacy : up to 150lm @ 350Ma (per watt)
- Color option: CW/NW/WW//Custom color
- CRI >73
- Rated Life of 100,000+ hrs
- No toxic chemicals / RoHs compliant
- 70%-80% energy saving compare to HPS/MH

DIMENSIONS

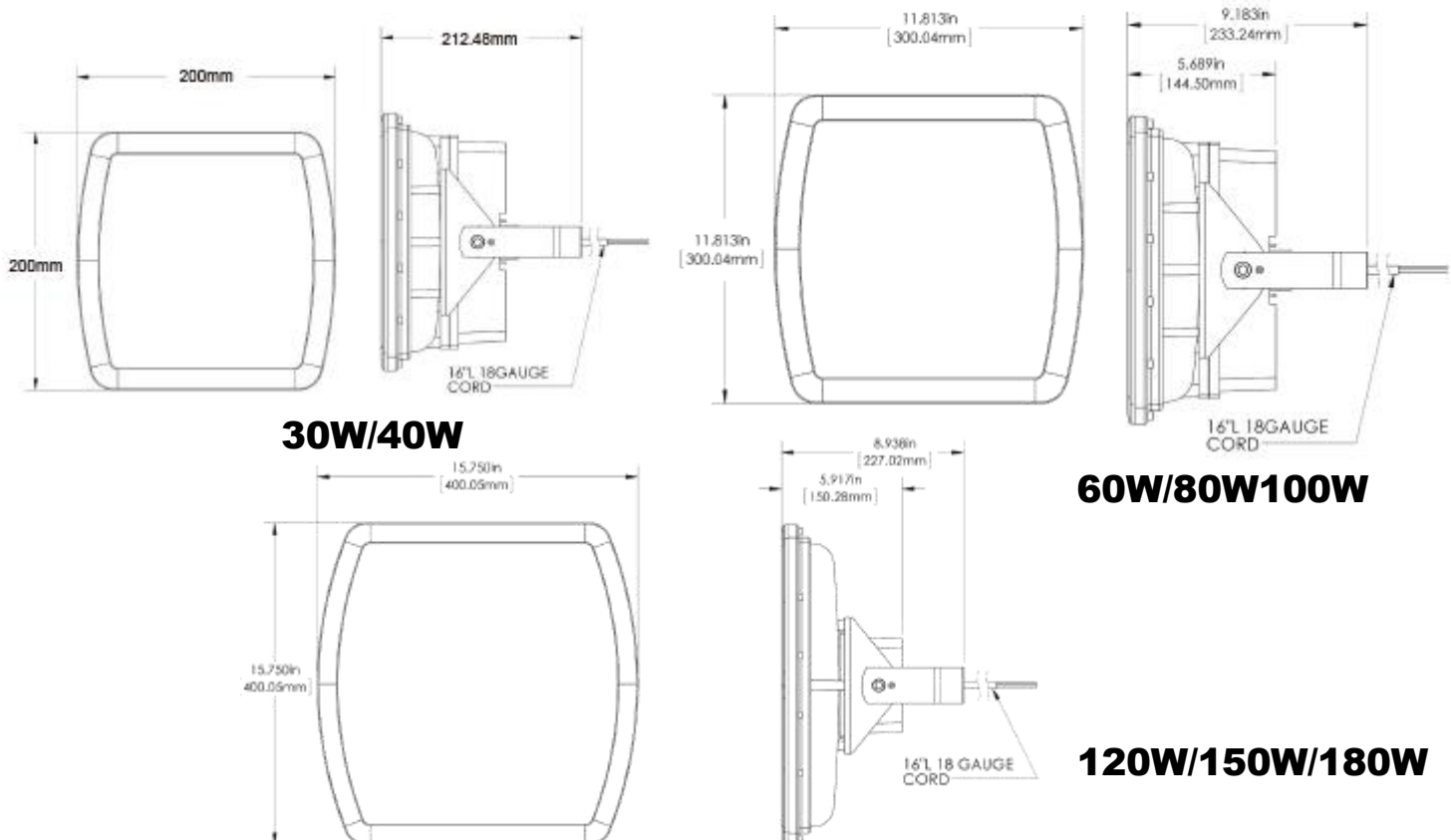

QUALIFICATION

- ISO 14001: Recognition with IAF & CNAS
- ISO 9001: Recognition with IAF & CNAS
- IEXEX (Global) : EX ec IIC T4 Gc
- ATEX Zone 1 : EX II 2G Ex eb mb IIA T4 Gb / ATEX Zone 2 : EX II 2D Ex tb IIIC T(95°C) Db
- UL844 (American): Class I Division 2 Group A, B, C, D
- UL1598 Luminaires; UL1598A Marine; UL8750
- CSA C22.2 No. 137-M1981

Technical Parameters

Power	30W/40W	60W/80W/100W	120W/150W/180W
Model No.	CES-J40S	CES-J100	CES-J200
Dimension	200 * 200 * 147mm	300*300*175m	400*400*185mm
Input Voltage & Frequency	AC100-277V/50/60Hz	AC100-277V/50/60Hz	AC100-277V/50/60Hz
Input current	0.35 ~ 0.55A	0.35 ~ 0.55A	0.35 ~ 0.55A
Power Factor (PF)	≥0.98	≥0.98	≥0.98
THD	<10%	<10%	<10%
LED QTY	Bridgelux 3030 24pcs/36pcs	Bridgelux 3030 84pcs/108pcs	Bridgelux 3030 156pcs/192pcs
Luminous Flux	3450lm/4600lm	6900lm/9200lm/11500lm	13800lm/17250lm/20700lm
CRI	>73	>73	>73
CCT Color	CW/NW/CW/Custom color	CW/NW/CW/Custom color	CW/NW/CW/Custom color
Beam Angle	120°x120°/60°x30°	120°x120°/60°x30°	120°x120°/60°x30°
Working Temp.	-40 °C to +55 °C	-40°C to +55°C	-40 °C to +55 °C
IP Grade	IP68	IP68	IP68
Lifespan	>100,000hrs	>100,000hrs	>100,000hrs
Housing	ADC12,painting powder coated ,aluminum alloy	ADC12,painting powder coated ,aluminum alloy	ADC12,painting powder coated ,aluminum alloy
PCB	2.5mm thickness,2oz copper	2.5mm thickness,2oz copper	2.5mm thickness,2oz copper
Tempered glass	4mm	4mm	4mm
Net weight	4kgs	7.5kgs	11.5kgs
Warranty	5 years	5 years	5 years

Application

- Suitable for oil well, refineries, gas station, petroleum and chemical industries, coal mine, military, airport, warehouse, marine etc.
- Zone1 & Zone2 gaseous environment, and Zone21 & Zone22 dust environment.



Distribution Curve

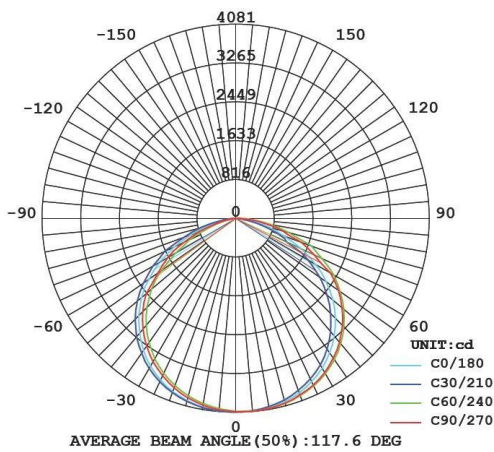

120°x120°

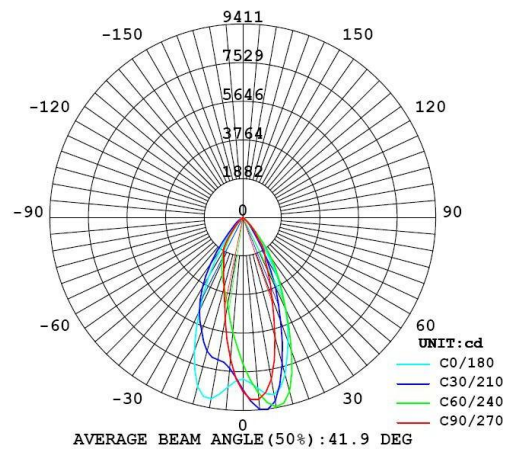

60°x30°

Packing Information

Model No.	Power	PCS/CTN	Net Weight	Gross Weight	Carton Size(mm)
CES-J40S	30W/40W	1	4kgs	4.5kgs	360*250x200mm
CES-J100	60W~100W	1	7.5kgs	8.5kgs	370x370x240mm
CES-J200	120~180W	1	11.5kgs	12.5kgs	460x460x240mm

Installation

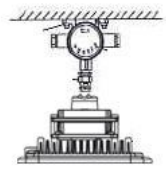

A. Ceiling Mount

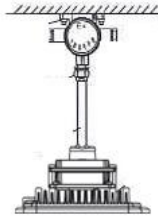

B. Drop Mounting

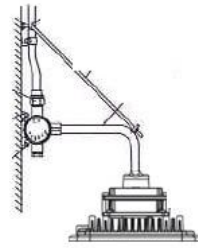

C. Wall Mount

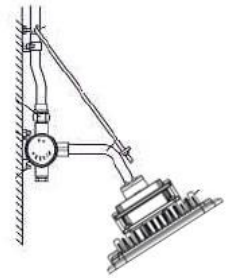

D. Wall Mount

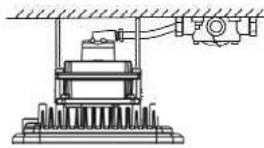

E. U-Bracket Mounting

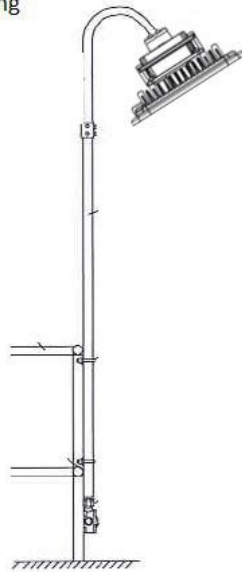
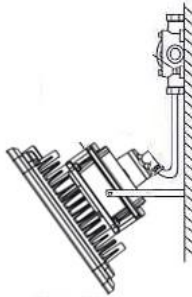

F. Pole Mount

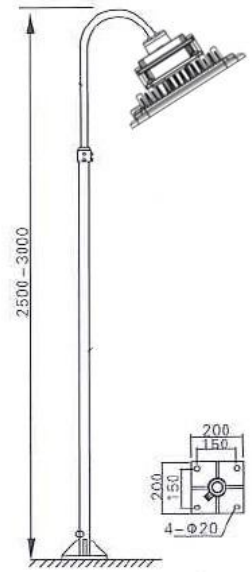

G. Pole Mount